

Article number: 2082264M8B

Description: E+G Mini indexing plunger
with/without rest position, GN 822.6-4-M8-B

Measures

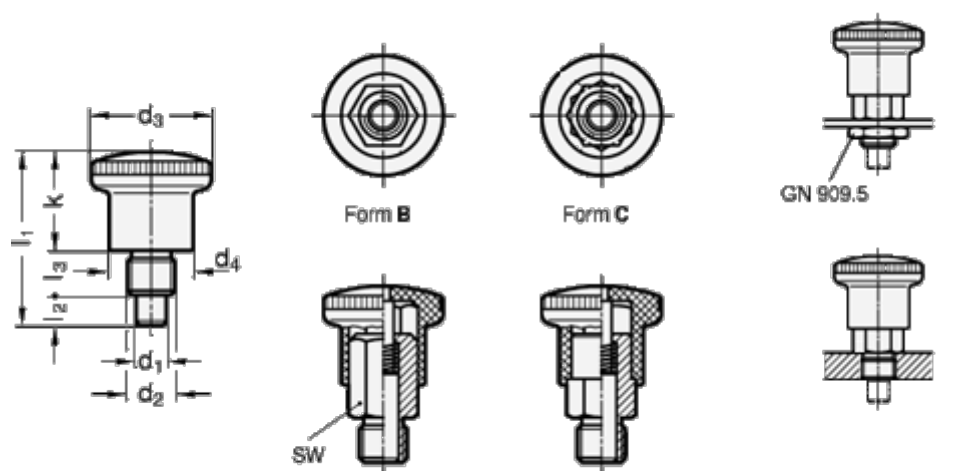

d1 = 4

d2 = M8

d3 = 21

d4 = 15

k = 16.5

l1 = 27.5

l2 = 5

l3 = 6

Spring load initial N = 4